

# Frese SIGMA Compact

## DN15-DN50

- DK **Montagevejledning**
- DE **Montageanleitung**
- EN **Mounting instructions**
- ES **Instrucciones de montaje**

Danmark · Tlf. +45 58 56 00 00  
 Deutschland · Tel. +49 (0)241 475 82 333  
 UK · Tel. +44 (0)1704 896012

**FIG 1**

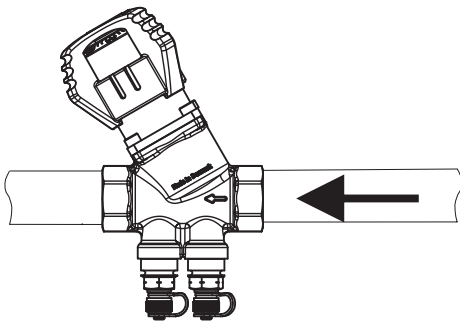

**Frese SIGMA Compact DN15 - DN50**

**FIG 2**

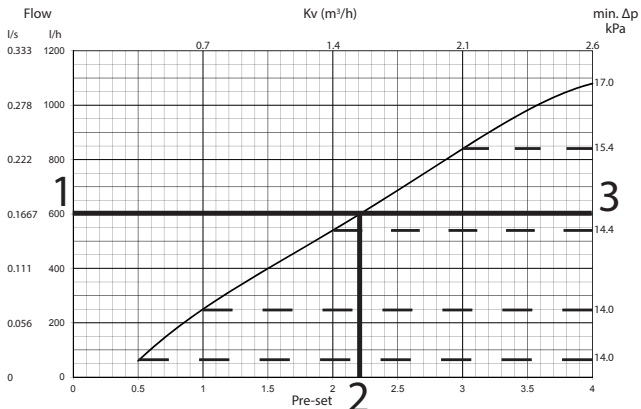

**Frese SIGMA Compact flow rate graph - DN 15 Low**

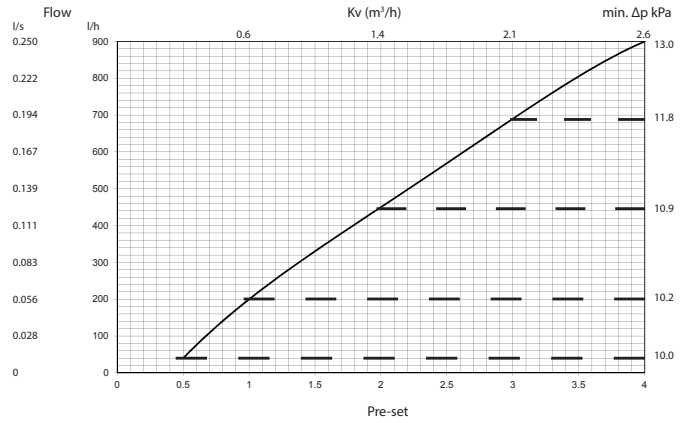

**Frese SIGMA Compact flow rate graph - DN 15 High**

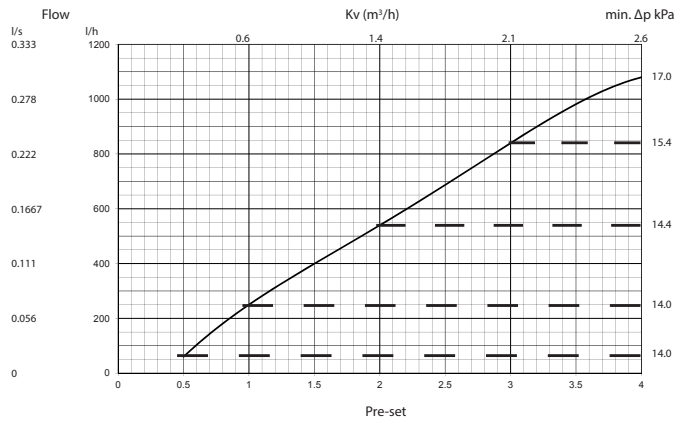

**Frese SIGMA Compact flow rate graph - DN 20 Low**

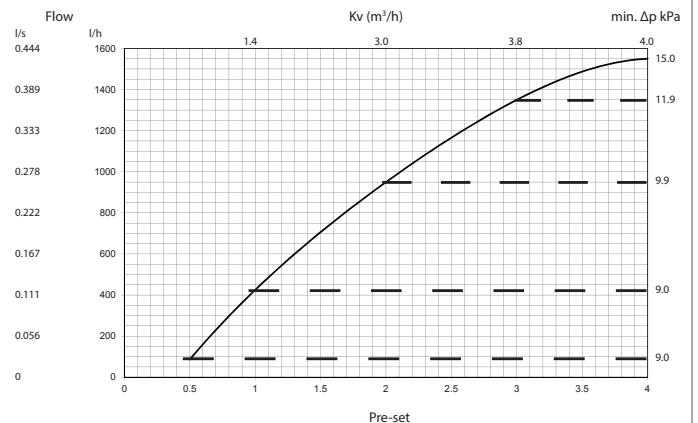

Frese SIGMA Compact flow rate graph - DN 20 High

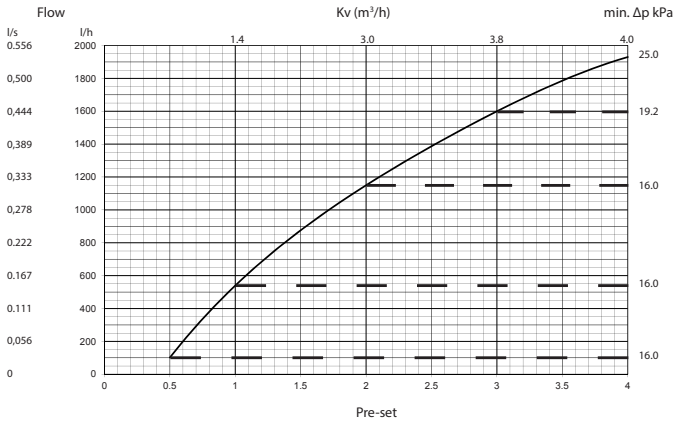

Frese SIGMA Compact flow rate graph - DN 32

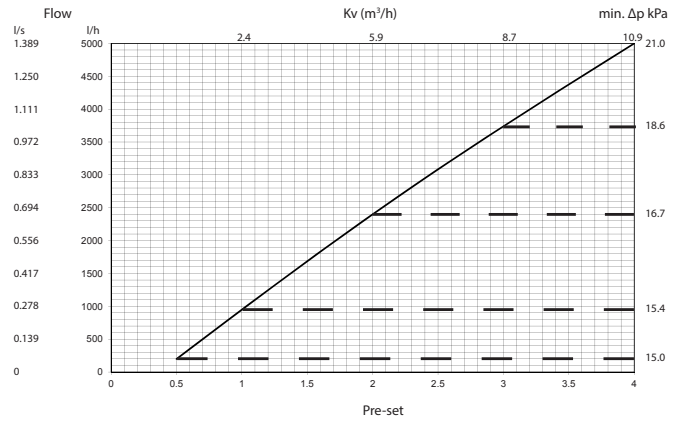

Frese SIGMA Compact flow rate graph - DN 25 Low

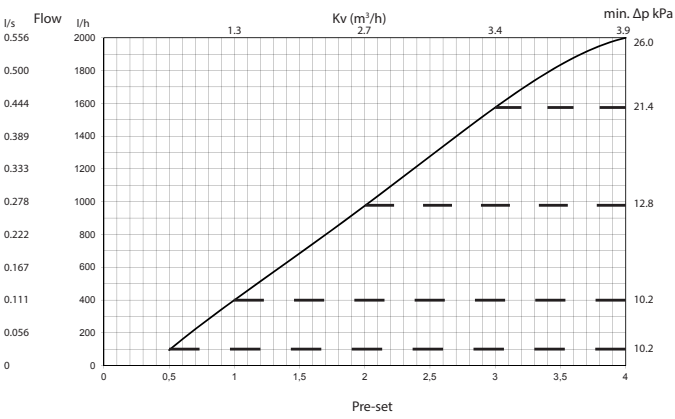

Frese SIGMA Compact flow rate graph - DN 40

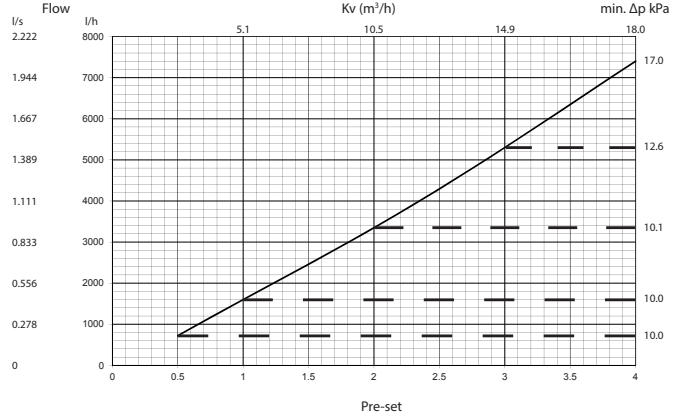

Frese SIGMA Compact flow rate graph - DN 25 High

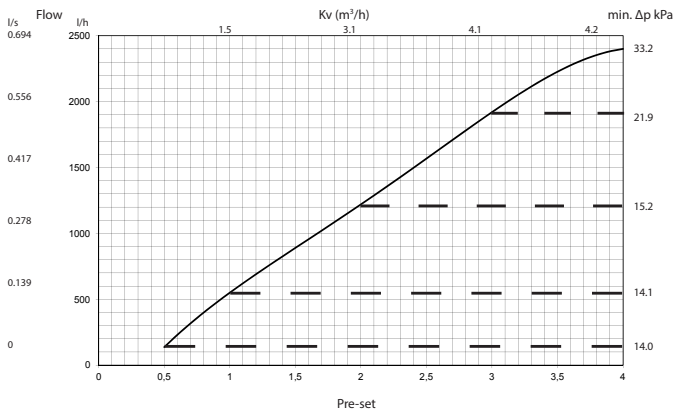

Frese SIGMA Compact flow rate graph - DN 50

